

easicook.co.uk

Spare Parts Manual

Leading UK Distributors
of Catering Equipment Since 1977

Sales - Repairs - Spares

Tel: 029 20747567

Fax: 029 20214100

Email: info@easicook.co.uk

[Click Here for Live Online Chat](#)

HILTA



lavabicchieri - lavatazze - lavastoviglie
lave-verres - lave-tasses - lave-vaisselle
lavavasos - lavacopas - lavavajillas
máquinas de lavar copos e louça
glasswashers and dishwashers
Gläser -und Geschirrspülmaschinen
glazenspoelmachines en vaatwassers

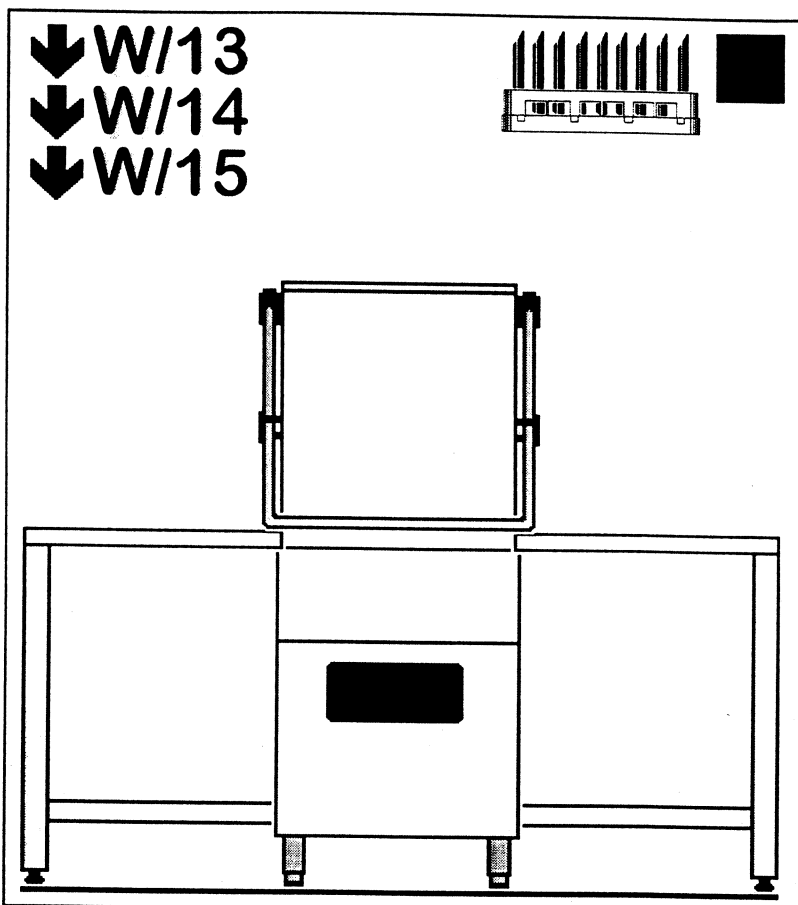

**PEZZI DI RICAMBIO
PIECES DETACHEES
PIEZAS DE RECAMBIO
SPARE PARTS
ERSATZTEILE
ONDERDELEN**

09/1998

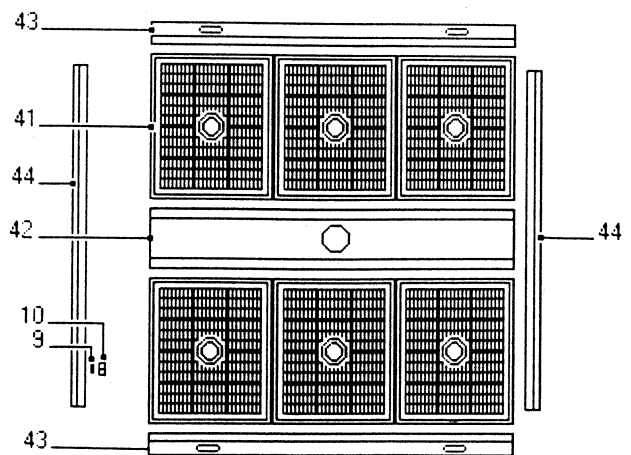
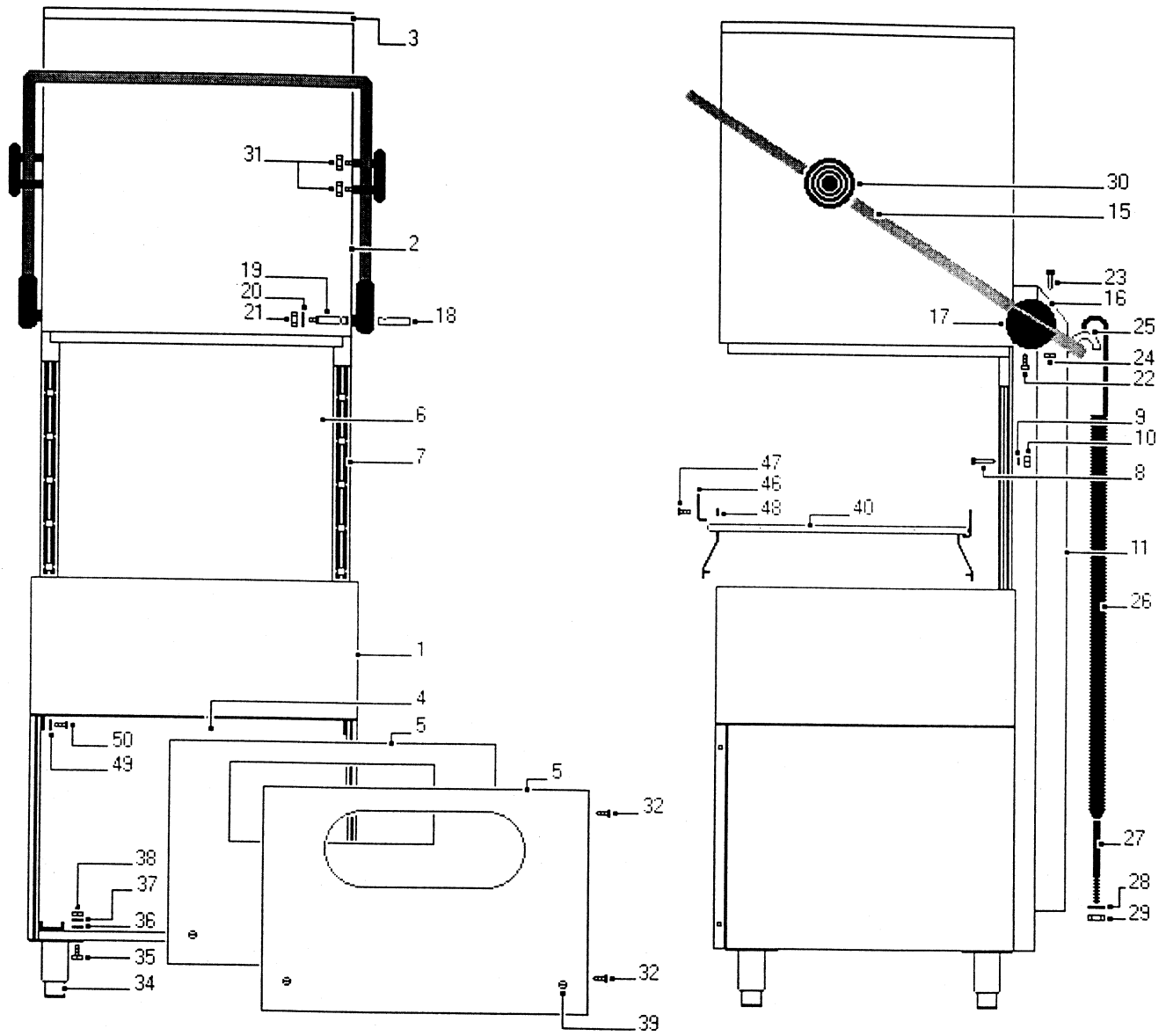

ref.	W/13	W/14	W/15	I	F	GB	Lit.	Euro
1	VASC15	VASC15	VASC15	VASCA DI LAVAGGIO	CUVE DE LAVAGE	WASH TANK	713.000	365,64
2	CAPO15	CAPO15	CAPO15	CAPOT	CAPOT	HOOD	843.000	432,31
3	PASU15	PASU15	PASU15	PANNELLO SUPERIORE	PANNEAU SUPERIEUR	TOP COVER	157.000	80,51
4	BASA15	BASA15	BASA15	BASAMENTO	SOCLE	BASE	524.000	268,72
5	CRBA14	CRBA14		CRUSCOTTO BASAMENTO	PANNEAU INFERIEUR	LOWER COVER	206.000	105,64
			CRBA15	CRUSCOTTO BASAMENTO	PANNEAU INFERIEUR	LOWER COVER	206.000	105,64
6	PAP015	PAP015	PAP015	PANNELLO POSTERIORE	PANNEAU POSTERIEUR	REAR COVER	157.000	80,51
7	GUSCCA	GUSCCA	GUSCCA	GUIDA SCORRIMENTO CAPOT	COULISSEAU CAPOT	HOOD GLIDER	72.000	36,92
8	VIGUCA	VIGUCA	VIGUCA	VITE GUIDE CAPOT	VIS	SCREW	1.100	0,56
9	ROPI06	ROPI06	ROPI06	RONDELLA	RONDELLE	WASHER	170	0,09
10	DAMEM06	DAMEM06	DAMEM06	DADO	ECROU	NUT	310	0,16
11	COTECE	COTECE	COTECE	COPERTURA TELAIO CENTR.	COUVERTURE	COVER	157.000	80,51
15	MAIN15	MAIN15	MAIN15	MANIGLIONE	POIGNEE	HANDLE	223.000	114,36
16	ATMASU13			ATTACCO SUP. MANIGLIONE	CONNECTION SUP. POIGNEE	HANDLE TOP CONNECTION	14.000	7,18
		ATMASU14		ATTACCO SUP. MANIGLIONE	CONNECTION SUP. POIGNEE	HANDLE TOP CONNECTION	14.000	7,18
			ATMASU15	ATTACCO SUP. MANIGLIONE	CONNECTION SUP. POIGNEE	HANDLE TOP CONNECTION	14.000	7,18
17	ATMAIN13			ATTACCO INF. MANIGLIONE	CONNECTION INF. POIGNEE	HANDLE LOWER CONN.	14.000	7,18
		ATMAIN14		ATTACCO INF. MANIGLIONE	CONNECTION INF. POIGNEE	HANDLE LOWER CONN.	14.000	7,18
			ATMAIN15	ATTACCO INF. MANIGLIONE	CONNECTION INF. POIGNEE	HANDLE LOWER CONN.	14.000	7,18
18	PEATMA	PEATMA	PEATMA	PERNO ATT. MANIGLIONE	AXE CONNECTION POIGNEE	CONNECTION PIN	13.000	6,67
19	BUPEMA	BUPEMA	BUPEMA	BUSSOLA PERNO MANIGLIONE	DOUILLE POUR AXE	BUSH	13.000	6,67
20	ROBUPE	ROBUPE	ROBUPE	RONDELLA BUSSOLA PERNO	RONDELLE	WASHER	1.800	0,92
21	DAOT038	DAOT038	DAOT038	DADO ESAGONALE 3/8"	ECROU	NUT	2.600	1,33
22	VIEI410	VIEI410	VIEI410	VITE 4x10	VIS	SCREW	390	0,20
23	VIEI655	VIEI655	VIEI655	VITE 6x55	VIS	SCREW	310	0,16
24	DAMEM06	DAMEM06	DAMEM06	DADO	ECROU	NUT	310	0,16
25	AGMO15	AGMO15	AGMO15	AGGANCIAMO MOLLA	SUPPORT RESSORT	SPRING SUPPORT	7.100	3,64
26	MOCA15	MOCA15	MOCA15	MOLLA CAPOT	RESSORT	SPRING	106.000	54,36
27	TIMOCA	TIMOCA	TIMOCA	TIRANTE MOLLA CAPOT	TIRANT	SPRING SHAFT	22.000	11,28
28	ROPI10	ROPI10	ROPI10	RONDELLA PIANA	RONDELLE	WASHER	380	0,19
29	DAMEM10	DAMEM10	DAMEM10	DADO	ECROU	NUT	980	0,50
30	SULAMA13	SULAMA14	SULAMA15	SUPPORTO MANIGLIONE	SUPPORT POIGNEE	HANDLE SUPPORT	21.000	10,77
31	DAMEM08	DAMEM08	DAMEM08	DADO	ECROU	NUT	540	0,28
32	VIAF3916	VIAF3916	VIAF3916	VITE AUTOFILETTANTE	VIS	SCREW	200	0,10
34	PIRE60	PIRE60	PIRE60	PIEDINO TELESCOPICO	PIED TELESCOPIQUE	TELESCOPIC FOOT	47.000	24,10
35	VITE1020	VITE1020	VITE1020	VITE 10x10	VIS	SCREW	1.500	0,77
36	ROPI10	ROPI10	ROPI10	RONDELLA PIANA 10	RONDELLE	WASHER	380	0,19
37	ROGR10	ROGR10	ROGR10	RONDELLA GROWER 10	RONDELLE	WASHER	270	0,14
38	DAMEM10	DAMEM10	DAMEM10	DADO M10	ECROU	NUT	980	0,50
39	VITC510	VITC510	VITC510	VITE 5x10	VIS	SCREW	330	0,17
40	SUINCE15	SUINCE15	SUINCE15	SUPPORTO CESTELLO	SUPPORT PANIER	BASKET RAMP	236.000	121,03
41	REFI40	REFI40	REFI40	FILTRO A CASSETTO	FILTRE TIROIR	WASH TANK FILTER	20.000	10,26
42	SUCE15	SUCE15	SUCE15	SUPPORTO CENTRAE	SUPPORT CENTRAL	CENTRAL SUPPORT	50.000	25,64
43	SUF115	SUF115	SUF115	SUPPORTO FILTRO	SUPPORT FILTRE	FILTER SUPPORT	31.000	15,90
44	SULA15	SULA15	SULA15	SUPPORTO LAT.FILTRO	SUPPORT LAT. FILTRE	SIDE FILTER SUPPORT	50.000	25,64
46	GULACE	GULACE	GULACE	GUIDA LATERALE CESTELLO	GLISSIERE LAT. PANIER	SIDE BASKET GLIDER	32.000	16,41
47	VIEI520	VIEI520	VIEI520	VITE FISS.GUIDA	VIS	SCREW	540	0,28
48	DAABM5	DAABM5	DAABM5	DADO AUTOBLOCCANTE	ECROU	NUT	610	0,31
49	ROPI05	ROPI05	ROPI05	RONDELLA PIANA	RONDELLE	WASHER	110	0,06
50	VITE512	VITE512	VITE512	VITE 5x12	VIS	SCREW	330	0,17

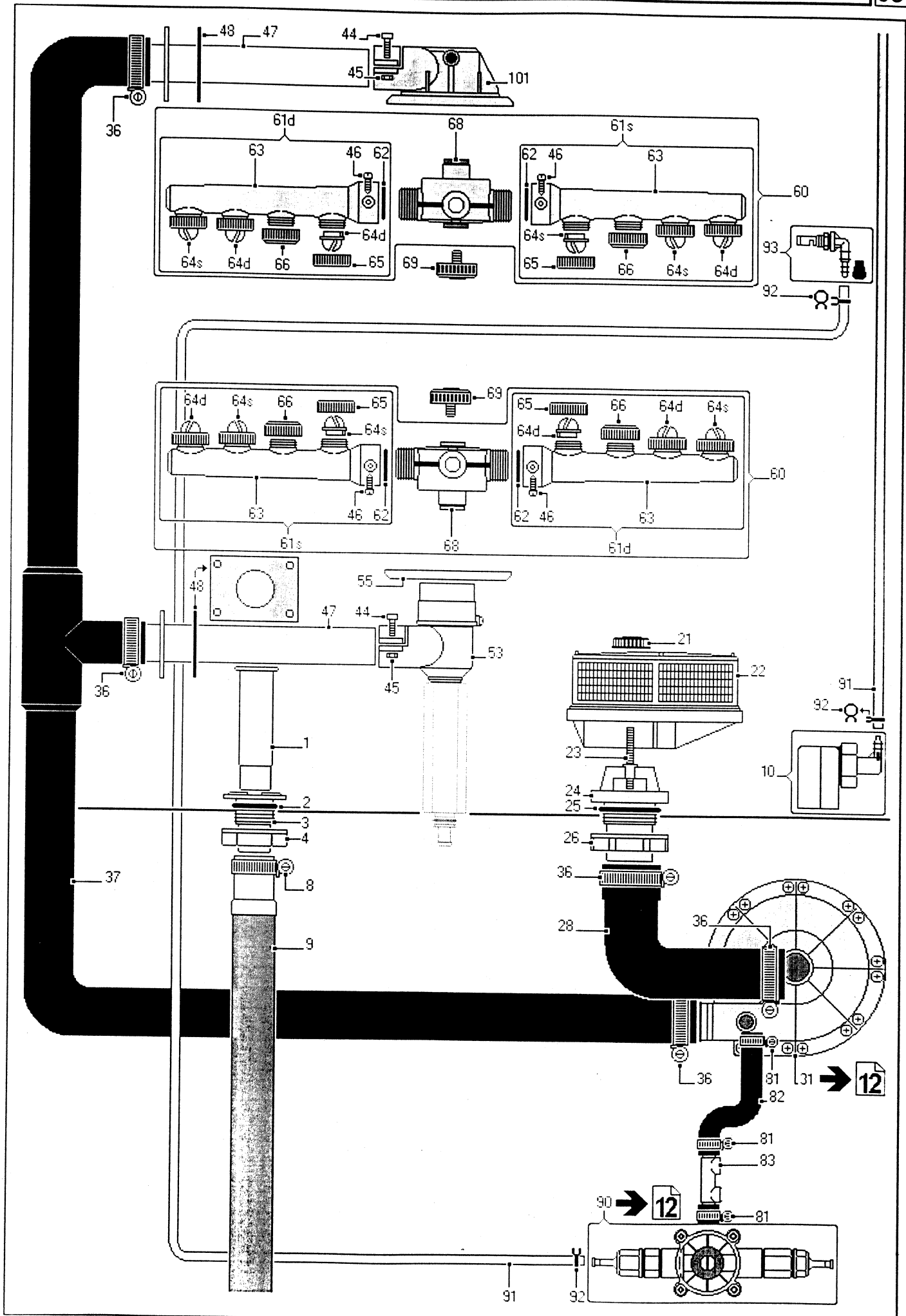

ref.	W/13	W/14	W/15	I	F	GB	Lit.	Euro
1	TPPLW15			TROPPOPIENO	TUBE DE TROP-PLEIN	OVERFLOW PIPE	27.000	13,85
2	OR3168			OR	JOINT OR	O RING	440	0,23
3	PISC30			PILETTA DI SCARICO	BONDE DE VIDANGE	DRAIN OUTLET	6.800	3,49
4	DAPL114			DADO IN PLASTICA - 1"1/4	ECROU	FIXING NUT	2.600	1,33
8	FATU40			FASCETTA - 40/60	COLLIER	JUBILEE CLIP	2.000	1,03
9	TUSC30			TUBO DI SCARICO	TUBE DE VIDANGE	DRAIN PIPE	29.000	14,87
10	09GAARIA			GRUPPO GABBIA ARIA	ENS.CHAMBRE COMPR.	AIR TRAP ASSEMBLY	17.000	8,72
21	NOFIFI			NOTTOLINO FILTRO	ECROU FIXATION FILTRE	FILTER FIXING NUT	2.900	1,49
22	FIPL60			FILTRO IN PLASTICA	FILTRE PLASTIQUE	PLASTIC FILTER	49.000	25,13
23	ASFI60			ASTINA FILTRO	AXE DE FILTRE	FILTER ROD	3.900	2,00
24	PIAS30			PILETTA ASPIRAZIONE	EMBASE DE FILTRE	FILTER SUPPORT	8.700	4,46
25	OR3187			OR	JOINT OR	O RING	540	0,28
26	DAPL112			DADO - 1"1/2	ECROU	FIXING NUT	2.900	1,49
28	MAAS30			MANICOTTO ASPIRAZIONE	DURITE ASPIRATION	WASH PUMP HOSE	29.000	14,87
31	EPIM100			POMPA HP 1.00-220-50Hz	POMPE HP 1.00-220-50Hz	PUMP HP 1.00-220-50Hz	314.000	161,03
	EPIM1006			POMPA HP 1.00-220-60Hz	POMPE HP 1.00-220-60Hz	PUMP HP 1.00-220-60Hz	335.000	171,79
36	FATU40			FASCETTA - 40/60	COLLIER	JUBILEE CLIP	2.000	1,03
37	MAMAW13			MANICOTTO MANDATA	DURITE LAVAGE	WASH RUBBER HOSE	164.000	84,10
44	VIEI516			VITE	VIS	SCREW	410	0,21
45	DAMEM05			DADO	ECROU	NUT	220	0,11
46	VIAF3995			VITE AUTOFILETTANTE	VIS	SCREW	160	0,08
47	TUINW13			TUBO INOX LAV.INFER.	TUBE INOX LAVAGE INFER.	S/S TUBE - LOWER WASH	56.000	28,72
48	GUSUW13			GUARNIZIONE SUGHERO	JOINT BOUCHON	CORK SEAL	3.300	1,69
53	SULRI30			SUPPORTO LAV/RISC.	COUDE LAV/RIN.INFER.	LOWER WASH/RINSE ELBOW	17.000	8,72
55	GHLAIN			GHIERA LAV.INFERIORE	DEVIATEUR LAVAGE INFER.	LOWER WASH DEVIATOR	4.200	2,15
60	09GILR40			GR.GIRANTE LAV/RISC.	ENS.BRAS LAV/RINÇAGE	WASH/RINSE ARM ASS.	139.000	71,28
61d	09ALDX40			GR.ASTA LAV. - DESTRO	ENS.BRAS LAV. - DROITE	WASH ARM ASS. - RIGHT	28.000	14,36
61s	09ALSX40			GR.ASTA LAV. - SINISTRO	ENS.BRAS LAV. - GAUCHE	WASH ARM ASS. - LEFT	28.000	14,36
62	OR124			OR	JOINT OR	O RING	260	0,13
63	ASLA40			ASTA DI LAVAGGIO	BRAS DE LAVAGE	WASH ARM	7.900	4,05
64d	GELALD			GETTO LAVAGGIO-DESTRO	JET LAVAGE-DROITE	WASH JET - RIGHT	1.200	0,62
64s	GELALS			GETTO LAVAGGIO-SINISTRO	JET LAVAGE-GAUCHE	WASH JET - LEFT	1.200	0,62
65	GHGELA			GHIERA GETTO LAVAGGIO	FIXATION JET LAVAGE	WASH JET FIXING RING	2.100	1,08
66	TAGELA			TAPPO GETTO LAVAGGIO	BOUCHON JET LAVAGE	WASH JET BLANK	2.200	1,13
68	MOGIFS			MOZZO GIRANTE	CENTRE LAVAGE/RINÇAGE	WASH/RINSE CENTER	26.000	13,33
69	NOFIMO			NOTTOLINO DI FISSAGGIO	ECROU DE FIXATION	FIXING NUT	9.800	5,03
81	FATU12			FASCETTA 12/20	COLLIER	JUBILEE CLIP	2.100	1,08
82	TG1117			TUBO GOMMA (x 1 cm.)	DURITE RINÇAGE (x 1 cm.)	RINSE HOSE (x 1 cm.)	100	0,05
83	RAPL1T			RACCORDO A T	RACCORD A T	T CONNECTION	6.500	3,33
90	DOBRDE			DOSATORE BRILLANTANTE	DOSEUR BRILLANT	RINSE AID DISPENSER	71.000	36,41
	TUSI48			TUBO SILICONE (x 1 cm.)	TUBE SILICONE (x 1 cm.)	SILICON HOSE (x 1 cm.)	100	0,05
92	FAMO46			FASCETTA A MOLLA	COLLIER RESSORT	SPRING CLIP	570	0,29
101	SULRSUW15			SUPPORTO LAV/RISC.SUPER.	SUPPORT LAV/RINÇ.SUPER.	TOP WASH/RINSE SUPPORT	21.000	10,77

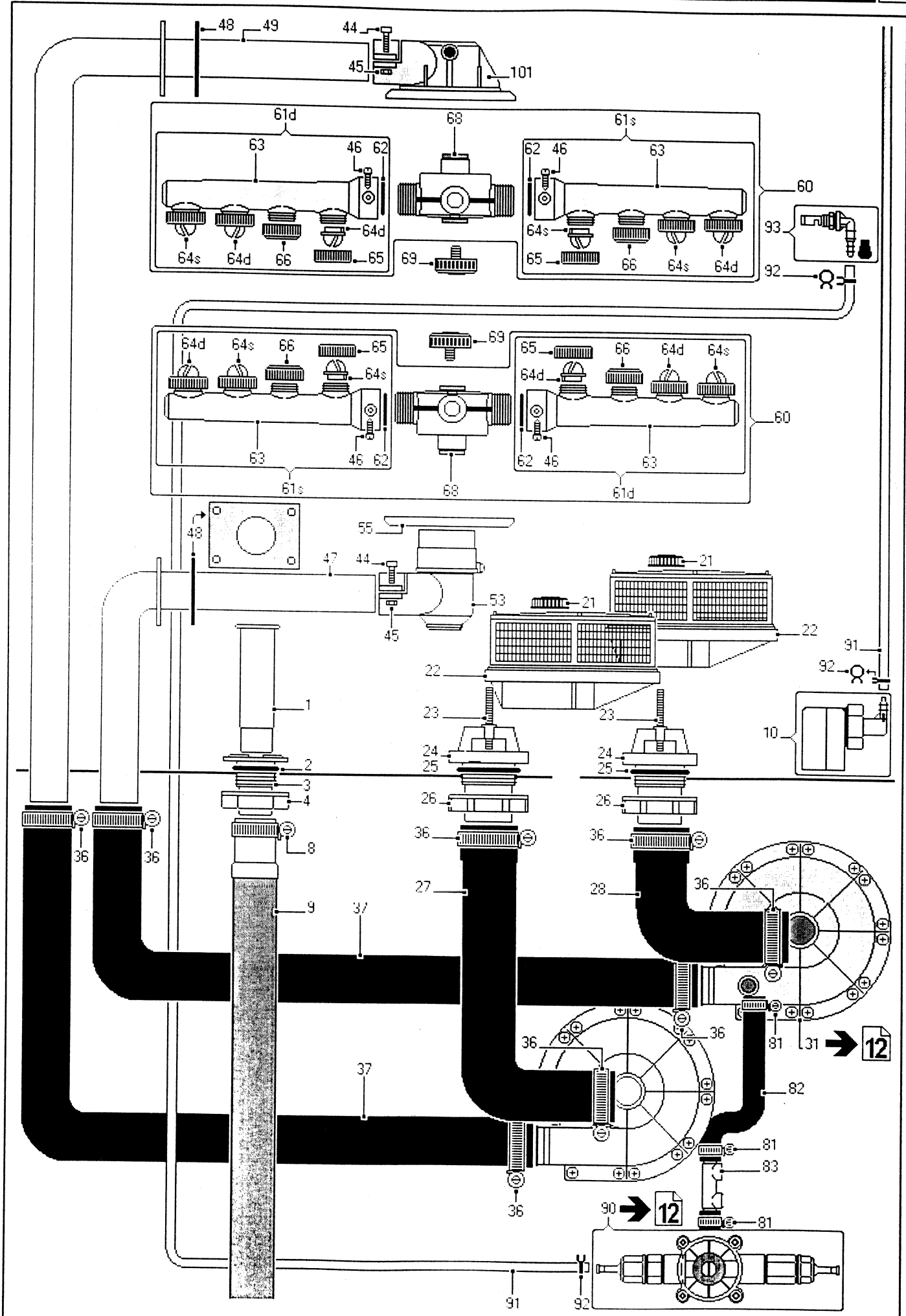

ref.	W/13	W/14	W/15	I	F	GB	Lit.	Euro
1		TPPLW15	TPPLW15	TROPPOPIENO	TUBE DE TROP-PLEIN	OVERFLOW PIPE	27.000	13,85
2		OR3168	OR3168	OR	JOINT OR	O RING	440	0,23
3		PISC30	PISC30	PILETTA DI SCARICO	BONDE DE VIDANGE	DRAIN OUTLET	6.800	3,49
4		DAPL114	DAPL114	DADO IN PLASTICA - 1"1/4	ECROU	FIXING NUT	2.600	1,33
8		FATU40	FATU40	FASCETTA - 40/60	COLLIER	JUBILEE CLIP	2.000	1,03
9		TUSC30	TUSC30	TUBO DI SCARICO	TUBE DE VIDANGE	DRAIN PIPE	29.000	14,87
10		09GAARIA	09GAARIA	GRUPPO GABBIA ARIA	ENS.CHAMBRE COMPR.	AIR TRAP ASSEMBLY	17.000	8,72
21		NOFIFI	NOFIFI	NOTTOLINO FILTRO	ECROU FIXATION FILTRE	FILTER FIXING NUT	2.900	1,49
22		FIPL60	FIPL60	FILTRO IN PLASTICA	FILTRE PLASTIQUE	PLASTIC FILTER	49.000	25,13
23		ASFI60	ASFI60	ASTINA FILTRO	AXE DE FILTRE	FILTER ROD	3.900	2,00
24		PIAS30	PIAS30	PILETTA ASPIRAZIONE	EMBASE DE FILTRE	FILTER SUPPORT	8.700	4,46
25		OR3187	OR3187	OR	JOINT OR	O RING	540	0,28
26		DAPL112	DAPL112	DADO - 1"1/2	ECROU	FIXING NUT	2.900	1,49
27		MAAS60	MAAS60	MANICOTTO ASPIRAZIONE	DURITE ASPIRATION	WASH PUMP HOSE	54.000	27,69
28		MAAS30	MAAS30	MANICOTTO ASPIRAZIONE	DURITE ASPIRATION	WASH PUMP HOSE	29.000	14,87
31		EPIM100	EPIM100	POMPA HP 1.00-220-50Hz	POMPE HP 1.00-220-50Hz	PUMP HP 1.00-220-50Hz	314.000	161,03
		EPIM1006	EPIM1006	POMPA HP 1.00-220-60Hz	POMPE HP 1.00-220-60Hz	PUMP HP 1.00-220-60Hz	335.000	171,79
36		FATU40	FATU40	FASCETTA - 40/60	COLLIER	JUBILEE CLIP	2.000	1,03
37		MAMAW15	MAMAW15	MANICOTTO MANDATA	DURITE LAVAGE	WASH RUBBER HOSE	48.000	24,62
44		VIEI516	VIEI516	VITE	VIS	SCREW	410	0,21
45		DAMEM05	DAMEM05	DADO	ECROU	NUT	220	0,11
46		VIAF3995	VIAF3995	VITE AUTOFILETTANTE	VIS	SCREW	160	0,08
47		TUINW14	TUINW14	TUBO INOX LAV.INFER.	TUBE INOX LAVAGE INFER.	S/S TUBE - LOWER WASH	67.000	34,36
48		GUSUW13	GUSUW13	GUARNIZIONE SUCHERO	JOINT BOUCHON	CORK SEAL	3.300	1,69
49		TUSUW14	TUSUW14	TUBO INOX LAV.SUPER.	TUBE INOX LAVAGE SUPER.	S/S TUBE - TOP WASH	102.000	52,31
53		SULRI30	SULRI30	SUPPORTO LAV/RISC.	COUDE LAV/RIN.INFER.	LOWER WASH/RINSE ELBOW	17.000	8,72
55		GHLAIN	GHLAIN	GHIERA LAV.INFERIORE	DEVIATEUR LAVAGE INFER.	LOWER WASH DEVIATOR	4.200	2,15
60		09GILR60	09GILR60	GR.GIRANTE LAV/RISC.	ENS.BRAS LAV/RINÇAGE	WASH/RINSE ARM ASS.	150.000	76,92
61d		09ALDX60	09ALDX60	GR.ASTA LAV. - DESTRO	ENS.BRAS LAV. - DROITE	WASH ARM ASS. - RIGHT	30.000	15,38
61s		09ALSX60	09ALSX60	GR.ASTA LAV. - SINISTRO	ENS.BRAS LAV. - GAUCHE	WASH ARM ASS. - LEFT	30.000	15,38
62		OR124	OR124	OR	JOINT OR	O RING	260	0,13
63		ASLA40	ASLA40	ASTA DI LAVAGGIO	BRAS DE LAVAGE	WASH ARM	7.900	4,05
64d		GELALD	GELALD	GETTO LAVAGGIO-DESTRO	JET LAVAGE-DROITE	WASH JET - RIGHT	1.200	0,62
64s		GELALS	GELALS	GETTO LAVAGGIO-SINISTRO	JET LAVAGE-GAUCHE	WASH JET - LEFT	1.200	0,62
65		GHGELA	GHGELA	GHIERA GETTO LAVAGGIO	FIXATION JET LAVAGE	WASH JET FIXING RING	2.100	1,08
66		TAGELA	TAGELA	TAPPO GETTO LAVAGGIO	BOUCHON JET LAVAGE	WASH JET BLANK	2.200	1,13
68		MOGIFS	MOGIFS	MOZZO GIRANTE	CENTRE LAVAGE/RINÇAGE	WASH/RINSE CENTER	26.000	13,33
69		NOFIMO	NOFIMO	NOTTOLINO DI FISSAGGIO	ECROU DE FIXATION	FIXING NUT	9.800	5,03
81		FATU12	FATU12	FASCETTA 12/20	COLLIER	JUBILEE CLIP	2.100	1,08
82		TG1017	TG1017	TUBO GOMMA (x 1 cm.)	DURITE RINÇAGE (x 1 cm.)	RINSE HOSE (x 1 cm.)	100	0,05
83		RAPL1T	RAPL1T	RACCORDO A T	RACCORD A T	T CONNECTION	6.500	3,33
90		DOBRDE	DOBRDE	DOSATORE BRILLANTANTE	DOSEUR BRILLANT	RINSE/ID DISPENSER	71.000	36,41
91		TUSI48	TUSI48	TUBO SILICONE (x 1 cm.)	TUBE SILICONE (x 1 cm.)	SILICON HOSE (x 1 cm.)	100	0,05
92		FAMO46	FAMO46	FASCETTA A MOLLA	COLLIER RESSORT	SPRING CLIP	570	0,29
101		SULRSUW15	SULRSUW15	SUPPORTO LAV/RISC.SUPER.	SUPPORT LAV/RINÇ.SUPER.	TOP WASH/RINSE SUPPORT	21.000	10,77

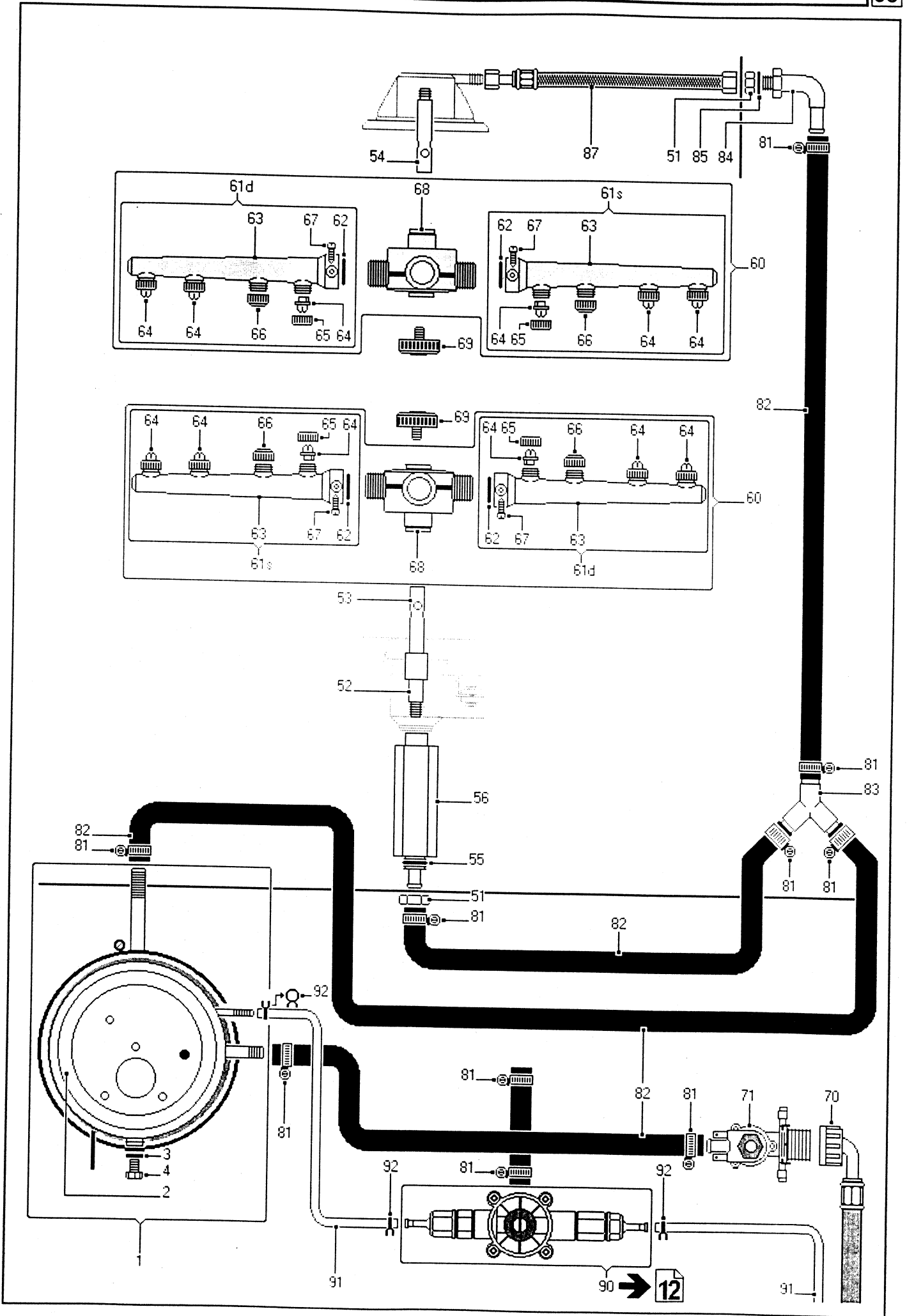

ref.	W/13	W/14	W/15	I	F	GB	Lit.	Euro
1	09BOTRW15	09BOTRW15	09BOTRW15	GR. BOILER TRIFASE	ENS. SURCHAUFF. TRI	RINSE TANK ASS. T/PHASE	212.000	108,72
2	BOTRW15	BOTRW15	BOTRW15	BOILER TRIFASE	SURCHAUFFEUR TRI	RINSE TANK - T/PHASE	211.000	108,21
3	GUTA12	GUTA12	GUTA12	GUARNIZIONE	JOINT	SEAL	240	0,12
4	VITE810	VITE810	VITE810	VITE ESAGON. 8x10	BOULON	BOLT	840	0,43
51	DAOT038	DAOT038	DAOT038	DADO - 3/8"	ECROU	NUT	2.600	1,33
52	PRPE30	PRPE30	PRPE30	PROLUNGA PERNO RISC.	EXTENSION ARBRE RINÇ.	RINSE SHAFT EXTENSION	17.000	8,72
53	PEIN30	PEIN30	PEIN30	PERNO INOX RISCIAQUO	ARBRE RINÇAGE	RINSE SHAFT	24.000	12,31
54	PEIN10	PEIN10	PEIN10	PERNO INOX RISCIAQUO	ARBRE RINÇAGE	RINSE SHAFT	24.000	12,31
55	OR122	OR122	OR122	OR	JOINT OR	O RING	240	0,12
56	SURIW15	SURIW15	SURIW15	SUPPORTO RISCIAQUO	TIGE RINÇAGE	RINSE SUPPORT	50.000	25,64
60	09GILR40			GR. GIRANTE LAV/RISC.	ENS. BRAS LAV/RINÇAGE	WASH/RINSE ARM ASS.	139.000	71,28
		09GILR60	09GILR60	GR. GIRANTE LAV/RISC.	ENS. BRAS LAV/RINÇAGE	WASH/RINSE ARM ASS.	150.000	76,92
61d	09ARID40	09ARID40	09ARID40	GR. ASTA RISC. -DESTRO	ENS. BRAS RINÇ. -DROITE	RINSE ARM ASS. -RIGHT	25.000	12,82
61s	09ARIS40	09ARIS40	09ARIS40	GR. ASTA RISC. -SINISTRO	ENS. BRAS RINÇ. -GAUCHE	RINSE ARM ASS. -LEFT	25.000	12,82
62	OR122	OR122	OR122	OR	JOINT OR	O RING	240	0,12
63	ASRI42	ASRI42	ASRI42	ASTA DI RISCIAQUO	BRAS DE RINÇAGE	RINSE ARM	7.400	3,79
64	GERIFS	GERIFS	GERIFS	GETTO DI RISCIAQUO	JET DE RINÇAGE	RINSE JET	870	0,45
65	GHGERI	GHGERI	GHGERI	GHIERA GETTO RISC.	FIXATION JET RINÇAGE	RINSE JET FIXING RING	2.000	1,03
66	TAGERI	TAGERI	TAGERI	TAPPO GETTO RISC.	BOUCHON JET RINÇ.	RINSE JET STOPPER	2.000	1,03
67	VIAF3995	VIAF3995	VIAF3995	VITE AUTOFILETTANTE	VIS	SCREW	160	0,08
68	MOGIFS	MOGIFS	MOGIFS	MOZZO GIRANTE	CENTRE LAVAGE/RINÇAGE	WASH/RINSE CENTER	26.000	13,33
69	NOFIMO	NOFIMO	NOFIMO	NOTTOLINO DI FISSAGGIO	ECROU DE FIXATION	FIXING NUT	9.800	5,03
70	TUCAVA	TUCAVA	TUCAVA	TUBO CARICO VASCA	TUYAU REMPLISSAGE	FILLING HOSE	12.000	6,15
71	ELVA1V	ELVA1V		ELETTROVALVOLA 1 VIA	ELECTROVANNE SIMPLE	1 WAY SOLENOID VALVE	23.000	11,79
			ELVA1V24	ELETTROVALVOLA 1 VIA	ELECTROVANNE SIMPLE	1 WAY SOLENOID VALVE	26.000	13,33
81	FATU12	FATU12	FATU12	FASCETTA 12/20	COLLIER	JUBILEE CLIP	2.100	1,08
82	TG1117	TG1117	TG1117	TUBO GOMMA (x 1 cm.)	DURITE RINÇAGE (x 1 cm.)	RINSE HOSE (x 1 cm.)	100	0,05
83	RAPL1Y	RAPL1Y	RAPL1Y	RACCORDO A Y	RACCORD A Y	Y CONNECTION	6.000	3,08
84	GOASRS	GOASRS	GOASRS	GOMITO ASTA RISC. SUPER.	COUDE RINÇAGE SUPERIEUR	UPPER RINSE ELBOW	6.000	3,08
85	GURA1525	GURA1525	GURA1525	GUARNIZIONE GOMMA	DURITE	SEAL	540	0,28
87	TURISUW15	TURISUW15	TURISUW15	TUBO RISCIAQUO SUPER.	TUBE RINÇAGE SUPERIEUR	UPPER RINSE TUBE	37.000	18,97
90	DOBRDE	DOBRDE	DOBRDE	DOSATORE BRILLANTANTE	DOSEUR BRILLANT	RINSE AID DISPENSER	71.000	36,41
91	TUSI48	TUSI48	TUSI48	TUBO SILICONE (x 1 cm.)	TUBE SILICONE (x 1 cm.)	SILICON HOSE (x 1 cm.)	100	0,05
92	FAMO46	FAMO46	FAMO46	FASCETTA A MOLLA	COLLIER RESSORT	SPRING CLIP	570	0,29

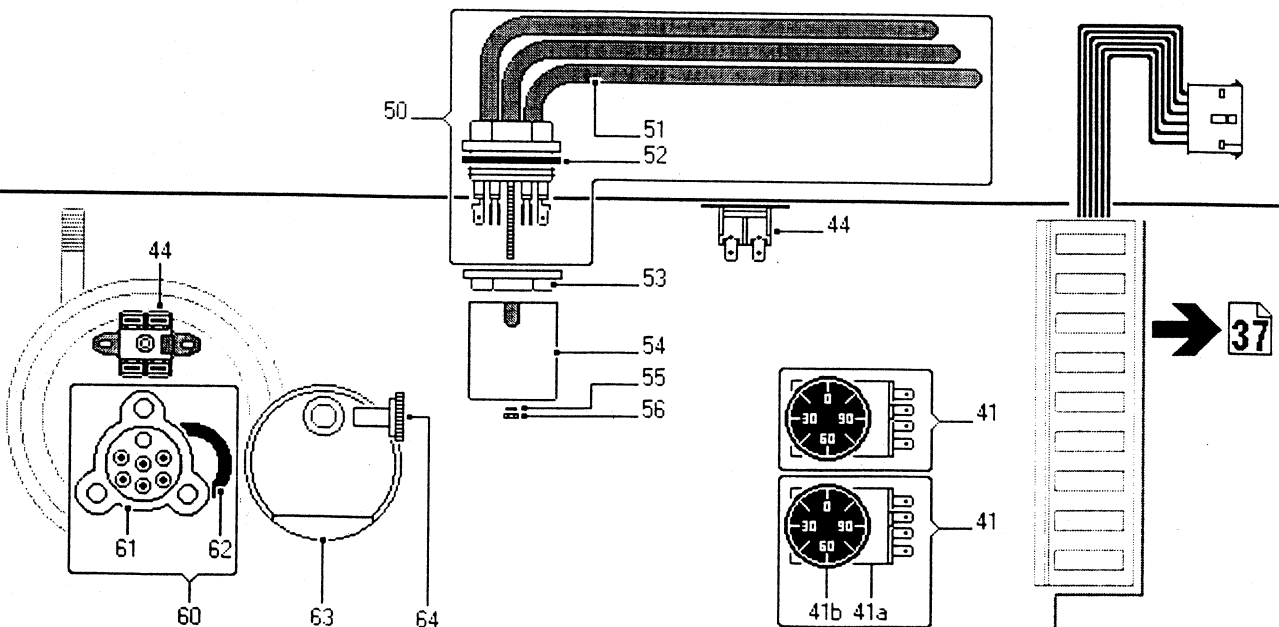
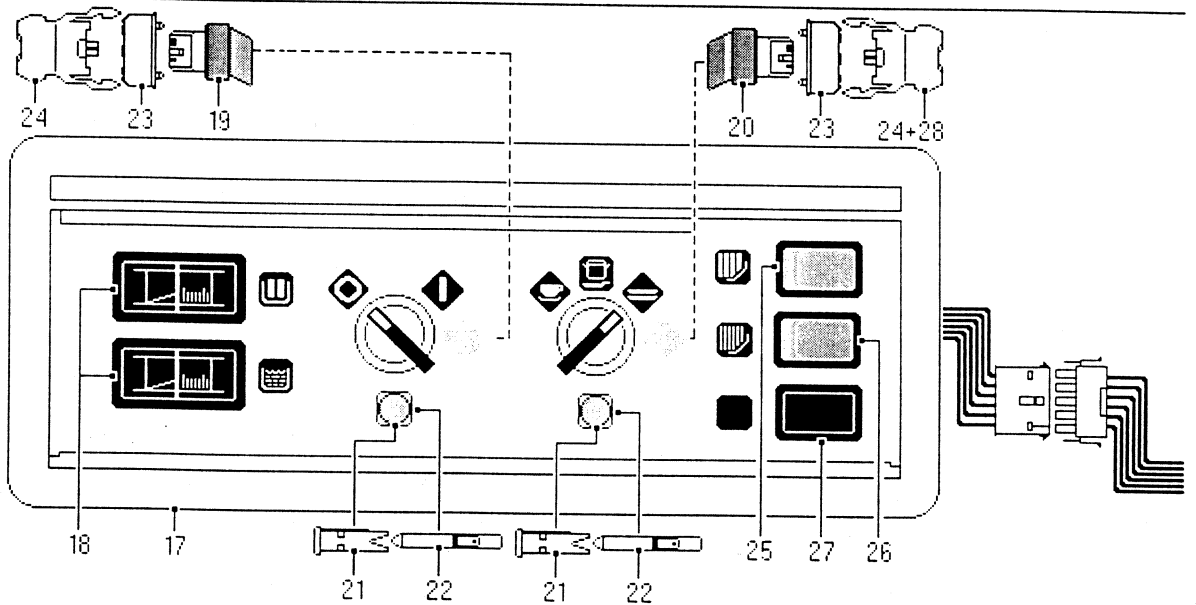
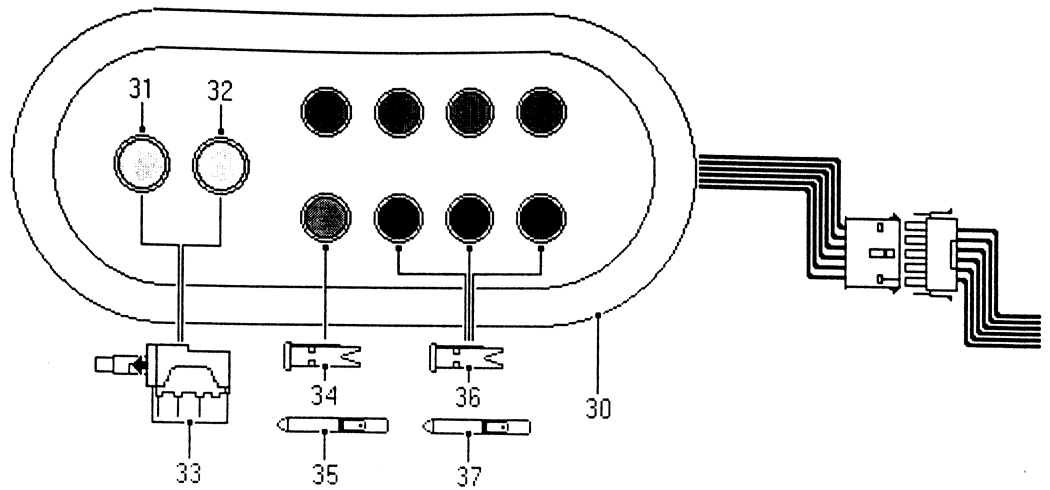

ref.	W/13	W/14	W/15	I	F	GB	Lit.	Euro
17			PACOW15	PANNELLO COMANDI	PANNEAU DE CONTROLE	CONTROL PANEL	35.000	17,95
18			TETELT	TERMOMETRO TEMPERATURE	THERMOMETRE	THERMOMETER	38.000	19,49
19			INGEW15	INTERRUTTORE GENERALE	INTERRUPTEUR GENERAL	MAIN OFF/ON SWITCH	31.000	15,90
20			SECIW15	SELETTORE CICLO	SELECTEUR CYCLE	CYCLE SELECTOR	31.000	15,90
21			GELUVEW15	GEMMA LUMINOSA VERDE	VOYANT VERT	GREEN LIGHT COVER	1.700	0,87
22			LASPW15	LAMPADA SPIA	AMPOULE	LIGHT BULB	4.600	2,36
23			SUINW15	SUPPORTO INTERRUTTORE	SUPPORT INTERRUPTEUR	SWITCH HOLDER	8.300	4,26
24			COELNO	CONTATTO "NO"	CONTACT "NO"	"NO" CONTACT	16.000	8,21
25			DELAW15	DEVIATORE LAV.MANUALE	DEVIATEUR LAV.MANUEL	MANUAL WASH DEVIATOR	11.000	5,64
26			PURIW15	PULSANTE RISC.MANUALE	BOUTON RINÇAGE MANUEL	MANUAL RINSE SWITCH	11.000	5,64
27			TANELA	TAPPO NERO LARGO	BOUCHON NOIR	BLACK BLANK	2.700	1,38
28			COELNC	CONTATTO "NC"	CONTACT "NC"	"NC" CONTACT	16.000	8,21
30	PACOW13			PANNELLO COMANDI	PANNEAU DE CONTROLE	CONTROL PANEL	29.000	14,87
		PACOW14		PANNELLO COMANDI	PANNEAU DE CONTROLE	CONTROL PANEL	29.000	14,87
31	TAINGE	TAINGE		TASTO INTERR.GENERALE	BOUTON INTERR.GENERAL	MAIN SWITCH COVER	2.900	1,49
32	TASECI	TASECI		TASTO SELETTORE CICLO	BOUTON SELECTEUR CYCLE	CYCLE SELECTOR COVER	2.900	1,49
33	DEGEW13	DEGEW13		DEVIATORE	DEVIATEUR	DEVIATOR	13.000	6,67
34	GELUVE	GELUVE		GEMMA LUMINOSA VERDE	VOYANT VERT	GREEN LIGHT COVER	1.700	0,87
35	LASPVE	LASPVE		LAMPADA SPIA VERDE	AMPOULE VERTE	GREEN LIGHT BULB	5.400	2,77
36	GELUGI	GELUGI		GEMMA LUMINOSA GIALLA	VOYANT JAUNE	AMBER LIGHT COVER	1.700	0,87
37	LASPGI	LASPGI		LAMPADA SPIA GIALLA	AMPOULE JAUNE	AMBER LIGHT BULB	4.600	2,36
41	09TERELR	09TERELR	09TERELR	GR. TERMOSTATO REGOL.	ENS.THERMOSTAT REGL.	ADJUST.THERMOSTAT ASS.	42.000	21,54
41a	TERELR	TERELR	TERELR	TERMOSTATO REGOLABILE	THERMOSTAT REGLABLE	ADJUSTABLE THERMOSTAT	37.000	18,97
41b	MATERE	MATERE	MATERE	MANOPOLA TERMOSTATO	MANETTE THERMOSTAT	THERMOSTAT KNOB	5.400	2,77
44	TESIW15C	TESIW15C	TESIW15C	TERMOSTATI SICUREZZA	THERMOSTAT DE SECURITE	SAFETY THERMOSTAT	24.000	12,31
50	09REVA45	09REVA45	09REVA45	GR.RESIST.VASCA - W.4500	ENS.RESIST.CUVE - W.4500	W/TANK EL. ASS. - W.4500	197.000	101,03
51	REVAM45	REVAM45	REVAM45	RESIST.VASCA - W.4500	RESIST.CUVE - W.4500	WASH TANK ELEM. - W.4500	195.000	100,00
52	GUREVA45	GUREVA45	GUREVA45	GUARNIZIONE RES.VASCA	JOINT	SEAL	2.200	1,13
53	DAOT114	DAOT114	DAOT114	DATO OTTONE 1"1/4	ECROU	NUT	3.300	1,69
54	PRREVA45	PRREVA45	PRREVA45	PROTEZIONE RES.VASCA	PROTECTION RESISTANCE	ELEMENT PROTECTION	6.500	3,33
55	ROPI05	ROPI05	ROPI05	RONDELLA PIANA	RONDELLE	WASHER	110	0,06
56	DAMEM05	DAMEM05	DAMEM05	DADO	ECROU	NUT	220	0,11
60	09REBO60			GR.RESIST.BOILER - W.6000	ENS.RES.SURCH. - W.6000	RINSE TANK ASS. - W.6000	151.000	77,44
		09REBO90	09REBO90	GR.RESIST.BOILER - W.9000	ENS.RES.SURCH. - W.9000	RINSE TANK ASS. - W.9000	151.000	77,44
61	REBOT60			RESISTENZA BOILER - W.6000	RESIST.SURCH. - W.6000	RINSE TANK ELEM. - W.6000	150.000	76,92
		REBOT90	REBOT90	RESISTENZA BOILER - W.9000	RESIST.SURCH. - W.9000	RINSE TANK ELEM. - W.9000	150.000	76,92
62	GUREBOT	GUREBOT	GUREBOT	GUARNIZ.RESIST.BOILER	JOINT RESIST. SURCHAUFF.	RINSE TANK ELEM. SEAL	1.500	0,77
63	PRREBOT	PRREBOT	PRREBOT	PROTEZIONE RES.TRIFASE	PROTECTION RES.TRI	RINSE EL.PROT. - T/PHASE	6.500	3,33
64	NOPRBOT	NOPRBOT	NOPRBOT	NOTTOLINO PROT.TRIFASE	ECROU PROTECT.TRI	NUT - T/PHASE PROTECT.	2.000	1,03

ref.	W/13	W/14	W/15	I	F	GB	Lit.	Euro
2	CAALTR	CAALTR	CAALTR	CAVO ALIMENT.TRIFASE	CABLE ELECTRIQUE TRI	ELECTRIC CABLE - T/PHASE	50.000	25,64
4	MOSUTR	MOSUTR	MOSITR	MORSETTIERA TRIFASE	BORNIER TRI	SPADE CONN. - T/PHASE	12.000	6,15
9	FIANDI	FIANDI	FIANDI	FILTRO ANTIDISTURBO	FILTRE ANTIPARASITAGE	SUPPRESSOR	15.000	7,69
11	BLTETE	BLTETE	BLTETE	BLOCCHETTO TERMINALE	MORSET DE BLOCAGE	TERMINAL BLOCK	3.100	1,59
12	MOPOFU	MOPOFU	MOPOFU	MORSETTO PORTA FUSIBILE	MORSET PORTE FUSIBLE	FUSE BLOCK	9.300	4,77
13	FUSIMO	FUSIMO	FUSIMO	FUSIBILE	FUSIBLE	FUSE	810	0,42
14	TEBOFA	TEBOFA		TELERUTTORE RES.VASCA	CONTACTEUR CUVE	CONTACTOR - WASH TANK	64.000	32,82
15	PRCIW13			PROGRAMMATORE CICLO	PROGRAMMATEUR CYCLE	CYCLE TIMER	167.000	85,64
		PRCIW14		PROGRAMMATORE CICLO	PROGRAMMATEUR CYCLE	CYCLE TIMER	167.000	85,64
			PRCIW15N	PROGRAMMATORE CICLO	PROGRAMMATEUR CYCLE	CYCLE TIMER	208.000	106,67
16	TEBOFA	TEBOFA		TELERUTTORE RES.BOILER	CONTACTEUR SURCHAUFF.	CONTACTOR - RINSE TANK	64.000	32,82
17	TEBOFA	TEBOFA		TELERUTTORE SICUREZZA	CONTACTEUR SECURITE	CONTACTOR - SAFETY	64.000	32,82
18	TEBOFA	TEBOFA		TELERUTTORE GENERALE	CONTACTEUR GENERAL	CONTACTOR - MAIN	64.000	32,82
19			TRCOW15	TRASFORMATORE	TRANSFORMATEUR	TRANSFORMER	130.000	66,67
21			TEGEW15	TELERUTTORE POMPE	CONTACTEUR POMPES	CONTACTOR - PUMPS	64.000	32,82
22			TEGEW15	TELERUTTORE SICUREZZA	CONTACTEUR SECURITE	CONTACTOR - SAFETY	64.000	32,82
23			TEGEW15	TELERUTTORE RES.BOILER	CONTACTEUR SURCHAUFF.	CONTACTOR - RINSE TANK	64.000	32,82
24			TEGEW15	TELERUTTORE RES.VASCA	CONTACTEUR CUVE	CONTACTOR - WASH TANK	64.000	32,82
25			TEPOW15	TELERUTTORE GENERALE	CONTACTEUR GENERAL	CONTACTOR - MAIN	59.000	30,26
26			TEPOW15	TELERUTTORE COMANDI	CONTACTEUR COMMANDES	CONTACTOR - CONTROLS	59.000	30,26
27			TEPOW15	CONTATTORE CAPOT	CONTACTEUR CAPOT	CONTACTOR - HOOD	59.000	30,26
28		RIPO60		RITARDATORE POMPA	RETARDEUR POMPE	WASH PUMP DELAYER	150.000	76,92
			RIPOW15	RITARDATORE POMPA	RETARDEUR POMPE	WASH PUMP DELAYER	125.000	64,10
28a		ZORIPO	ZORIPO	ZOCOLO RITARDATORE	SOCLE RETARDEUR POMPE	BASE FOR PUMP DELAYER	23.000	11,79
34	PRL110	PRL110	PRL110	PRESSOSTATO	PRESSOSTAT	PRESSURE SWITCH	33.000	16,92
35	MICA2C	MICA2C	MICA2C	MICRO - 2 CONTATTI	MICRO - 2 CONTACTES	MICRO SW. - 2 CONTACTS	14.000	7,18
36	MICA3C	MICA3C	MICA3C	MICRO - 3 CONTATTI	MICRO - 3 CONTACTES	MICRO SW. - 3 CONTACTS	16.000	8,21
37	MICA3C	MICA3C	MICA3C	MICRO - 3 CONTATTI	MICRO - 3 CONTACTES	MICRO SW. - 3 CONTACTS	16.000	8,21
38	CAMIPO	CAMIPO	CAMIPO	CABLAGGIO MICRO	CABLAGE MICRO	MICRO SW. - LOOM	29.000	14,87
44	CAGE13			CABLAGGIO SU PIASTRA	CABLAGE	WIRING LOOM	195.000	100,00
		CAGE14		CABLAGGIO SU PIASTRA	CABLAGE	WIRING LOOM	204.000	104,62