

- lavastoviglie - lavabicchieri
- dishwashers - glasswashers

small

medium

large

...su tutta la gamma, per la qualità...

Da oltre 35 anni Teikos applica la propria esperienza nel produrre macchine solide, efficienti e affidabili – partners ideali per il moderno professionista della ristorazione. Componentistica, progettazione e materiali utilizzati esclusivamente in funzione del reale risultato della loro simbiosi. Promessa mantenuta!



Giranti di lavaggio e risciacquo in acciaio inox separate su circuiti indipendenti: per la migliore performance di risciacquo.

Upper and lower stainless steel wash and rinse arms, with reinforced end caps, work separately on independent circuits, assuring a perfectly balanced and thorough washing and highly efficient rinsing.



Lavaggio e risciacquo superiore ed inferiore: risultati senza compromessi in un ciclo di 150 secondi.

Upper and lower washing and rinsing: perfect results without compromises in a 150 sec. cycle.



...on the whole range, for the best quality...

More than 35 years of experience and technical know-how applied in the production of highly efficient and reliable industrial washing equipment – ideal partners of a modern professional in the food and hotel industry. Advanced technology and product design, careful selection of components and materials – a perfect symbiosis for real results. The promise kept!



Porta bilanciata smontabile e ispezionabile, con cerniere rinforzate e senza guarnizioni soggette ad invecchiamento.

Double skinned stainless steel door, with balanced design and reinforced hinges, for a finger light opening and reliable action year after year; fully removable, without rubber seals subject to ageing and deterioration.



Carozzeria e porta a doppia parete: per una macchina più silenziosa e con minor emissione di calore all'esterno. Robusta di costruzione, facile da usare.

All double skinned stainless steel construction, for excellent sound and heat insulation, assures long life and years of efficient and reliable operation. Robust and simple, friendly to use and easy to service.

Un passo avanti ...rispettando l'ambiente

Abbiamo ridotto al minimo l'utilizzo di parti in plastica; applichiamo per lavaggio e risciacquo pompe ad alta efficienza attentamente dimensionate: il nostro cliente consuma meno energia e...l'ambiente ringrazia.



We have reduced to a minimum the use of plastic components; our washing and rinsing pumps have been carefully studied and designed for maximal efficiency: our customer saves energy and ...the environment is grateful.



Tutte le componenti sono elettromeccaniche, lo smontaggio delle parti soggette a manutenzione o pulizia ordinaria si eseguono senza l'uso di attrezzi. I termostati che gestiscono le temperature di lavaggio e risciacquo sono entrambi regolabili, per un set-up ottimale e personalizzato.

All the components are electromechanical, the parts subject to daily cleaning and maintenance are all removable and can easily be cleaned and serviced without the need for tools. Adjustable thermostats give the possibility to adjust the temperature of both washing and rinsing, assuring a perfect and personalized set-up to suit every requirement.

A step forward... ...respecting the environment

CONSIGLIO / ADVICE



Mi serve la pompa di scarico?

Le lavastoviglie industriali scaricano per gravità. Se lo scarico del Vostro impianto è alto o lontano dal punto di installazione della macchina, la pompa di scarico aiuta l'acqua ad essere evacuata. Inoltre, la pompa di scarico permette lo svuotamento della vasca con la semplice pressione di un tasto. Attenzione! Il tubo di scarico corrugato va adeguato alla distanza tra la macchina e lo scarico a muro, mantenendo la possibilità di estrarre la macchina.

Do I need a drain pump?

Industrial dishwashers drain water by gravity. But, if the drain outlet on Your site is high or placed far away from the drain point on Your dishwasher, a drain pump will help the drainage process. Furthermore, a drain pump allows efficient draining of the wash tank by pressing one button only.

Attention! The length of the spiral drain pipe depends on the distance between the machine and the drain outlet, but bear in mind the eventual need to extract the machine from its position!



small



medium

bar/bar

TS820

370x370mm
cesto basket
285mm
h. porta door h.

TS821

Ø370mm
cesto basket
285mm
h. porta door h.

TS830

400x400mm
cesto basket
300mm
h. porta door h.

media ristorazione/medium size restaurants

TS603

500x500mm
cesto basket
330mm
h. porta door h.

TS601

500x500mm
cesto basket
330mm
h. porta door h.

TS723

500x500mm
cesto basket
500mm
h. porta door h.

TS721

500x500mm
cesto basket
500mm
h. porta door h.



Lunga vita!

Un detergente aggressivo mantiene pulita la vasca, ma aggredisce le Vostre stoviglie e non si occupa affatto del sistema di risciacquo; per garantirne massima efficienza ed estrema longevità, l'applicazione di un buon decalcificatore per acque calcaree è la miglior soluzione.



large

grande ristorazione/big restaurants

TS983

550x550mm
cesto basket

600mm
h. porta door h.

TS103

500x500mm
cesto basket

400mm
h. porta door h.



Long life!

An aggressive detergent will keep the wash tank clean, but it will damage Your dishes and it will not take care of the rinse system at all; a regular use of a good water softener is the best solution for maximum efficiency and extreme longevity of Your dishwasher.

CONSIGLIO / ADVICE



Teikos
catering equipment

TS820

A DOPPIA PARETE INOX
DOUBLE SKINNED STAINLESS STEEL

LAVABICCHIERI

- > Comandi superiori
- > Stop ciclo su apertura porta
- > Dosatore del brillantante incorporato
- > Alimentazione 220/240V 1F 50Hz
- > Potenza max. 2.7 Kw (picco)

In dotazione

- > 1 x cesto quadro piano
- > 1 x inserto porta piattini
- > 1 x portaposate
- > 1 x tubo di carico
- > 1 x tubo di scarico (già installato)

GLASSWASHER

- > Top controls
- > Safety cycle stop on door opening
- > Built-in rinse-aid dispenser
- > Power supply 220/240V 1F 50Hz
- > Max power 2.7 Kw

Supplied with

- > 1 x flat square basket
- > 1 x plate rack insert
- > 1 x cutlery basket
- > 1 x inlet hose
- > 1 x drain hose (already fitted)



370 x 370

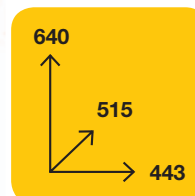
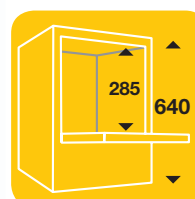

TS821



Ø 370



modelli models

TS820 (TS821)

modello standard
standard model

TS820 (TS821) 2R

doppio risciacquo caldo/freddo selezionabile
selectable hot/cold rinse phase

TS820 (TS821) Ps

pompa di scarico automatica
automatic drain pump

TS820 (TS821) A

addolcitore acqua a resine incorporato
built-in resin water softener

TS820 (TS821) Det

dosatore del detergente liquido incorporato
built-in liquid detergent dispenser

TS820 (TS821) Det 2R

doppio risciacquo caldo/freddo selezionabile
dosatore del detergente liquido incorporato
selectable hot/cold rinse phase
built-in liquid detergent dispenser

TS820 (TS821) Det Ps

dosatore del detergente liquido incorporato
pompa di scarico automatica
built-in liquid detergent dispenser
automatic drain pump

TS830

A DOPPIA PARETE INOX
DOUBLE SKINNED STAINLESS STEEL

LAVABICCHIERI

- > Comandi superiori
- > Stop ciclo su apertura porta
- > Dosatore del brillantante incorporato
- > Alimentazione 220/240V 1F 50Hz
- > Potenza max. 2.7 Kw (picco)

In dotazione

- > 1 x cesto quadro piano
- > 1 x inserto porta piattini
- > 1 x portaposate
- > 1 x tubo di carico
- > 1 x tubo di scarico (già installato)



GLASSWASHER

- > Top controls
- > Safety cycle stop on door opening
- > Built-in rinse-aid dispenser
- > Power supply 220/240V 1F 50Hz
- > Max power 2.7 Kw

Supplied with

- > 1 x flat square basket
- > 1 x plate rack insert
- > 1 x cutlery basket
- > 1 x inlet hose
- > 1 x drain hose (already fitted)

400 x 400

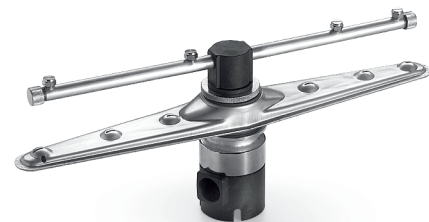
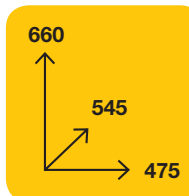

Girante di risciacquo separata, in inox. Necessita di pochissima pressione idrica per lavorare al massimo.

Separate rinse arms, in stainless steel; maximum efficiency with minimum water pressure.

modelli models

caratteristiche

- | modelli models | caratteristiche |
|----------------|---|
| > TS830 | modello standard |
| > TS830 2R | doppio risciacquo caldo/freddo selezionabile |
| > TS830 Ps | pompa di scarico automatica |
| > TS830 A | addolcitore acqua a resine incorporato |
| > TS830 Det | dosatore del detergente liquido incorporato |
| > TS830 Det 2R | doppio risciacquo caldo/freddo selezionabile
dosatore del detergente liquido incorporato |
| > TS830 Det Ps | dosatore del detergente liquido incorporato
pompa di scarico automatica |

features

- | features |
|-------------------------------------|
| standard model |
| selectable hot/cold rinse phase |
| automatic drain pump |
| built-in resin water softener |
| built-in liquid detergent dispenser |
| selectable hot/cold rinse phase |
| built-in liquid detergent dispenser |
| built-in liquid detergent dispenser |
| automatic drain pump |

TS603

A DOPPIA PARETE INOX
DOUBLE SKINNED STAINLESS STEEL

LAVABICCHIERI / LAVAPIATTI

- > Comandi laterali
- > Stop ciclo su apertura porta
- > Dosatore del brillantante incorporato
- > Filtro inox aspirazione pompa
- > Alimentazione 380/415V 3F 50Hz
- > Potenza max. 5.3 Kw (picco)

In dotazione

- > 1 x cesto quadro piano
- > 1 x cesto quadro piatti
- > 1 x portaposate
- > 1 x tubo di carico
- > 1 x tubo di scarico (già installato)

GLASSWASHER / DISHWASHER

- > Side controls
- > Safety cycle stop on door opening
- > Built-in rinse-aid dispenser
- > Stainless steel filter on washing pump
- > Power supply 380/415V 3F 50Hz
- > Max power 5.3 Kw

Supplied with

- > 1 x flat square basket
- > 1 x square plate basket
- > 1 x cutlery basket
- > 1 x inlet hose
- > 1 x drain hose (already fitted)



500 x 500

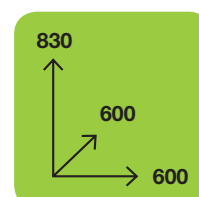
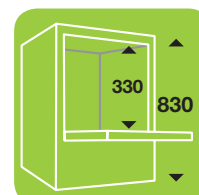

CONSIGLIO / ADVICE



Disporre le stoviglie!

Riempire il cesto in modo ordinato senza accavallamenti tra gli oggetti favorirà l'azione detergente dell'acqua. Posizionare oggetti alti e stretti al centro del cesto è la soluzione migliore per garantire un perfetto lavaggio interno.

How to place the dishes?

To fill the basket in a tidy way, without placing the dishes on top of each other, will enhance the effectiveness of the washing process. The best solution which will guarantee a perfect internal washing is to place the high and thin objects in the center of the basket.

modelli models

TS603

caratteristiche features

modello standard
standard model

TS603 Ps

pompa di scarico automatica
automatic drain pump

TS603 Det

dosatore del detergente liquido incorporato
built-in liquid detergent dispenser

TS603 Det Ps

dosatore del detergente liquido incorporato
pompa di scarico automatica
built-in liquid detergent dispenser
automatic drain pump

TS601 A DOPPIA PARETE INOX
DOUBLE SKINNED STAINLESS STEEL



LAVABICCHIERI / LAVAPIATTI

- > Comandi laterali
- > Stop ciclo su apertura porta
- > Dosatore del brillantante incorporato
- > Alimentazione 220/240V 1F 50Hz
- > Potenza max. 3.3 Kw (picco)

In dotazione

- > vedi TS603

GLASSWASHER / DISHWASHER

- > Side controls
- > Safety cycle stop on door opening
- > Built-in rinse-aid dispenser
- > Power supply 220/240V 1F 50Hz
- > Max power 3.3 Kw

Supplied with

- > see TS603

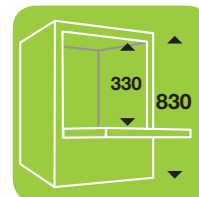
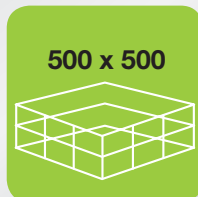

modelli models

- > TS601
- > TS601 Ps
- > TS601 Det
- > TS601 Det Ps

caratteristiche

- modello standard
- pompa di scarico automatica
- dosatore del detergente liquido incorporato
- dosatore del detergente liquido incorporato
- pompa di scarico automatica

features

- standard model
- automatic drain pump
- built-in liquid detergent dispenser
- built-in liquid detergent dispenser
- automatic drain pump

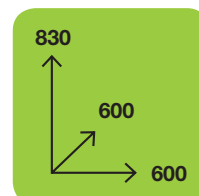

Girante di risciacquo separata, in inox.
Necessita di pochissima pressione idrica per lavorare al massimo.

Separate rinse arms, in stainless steel; maximum efficiency with minimum water pressure.

Guarnizioni di scorrimento in carbographe per silenziosità e scorrevolezza.

Sliding seals in carbographe for maximum sliding with minimum noise emission.

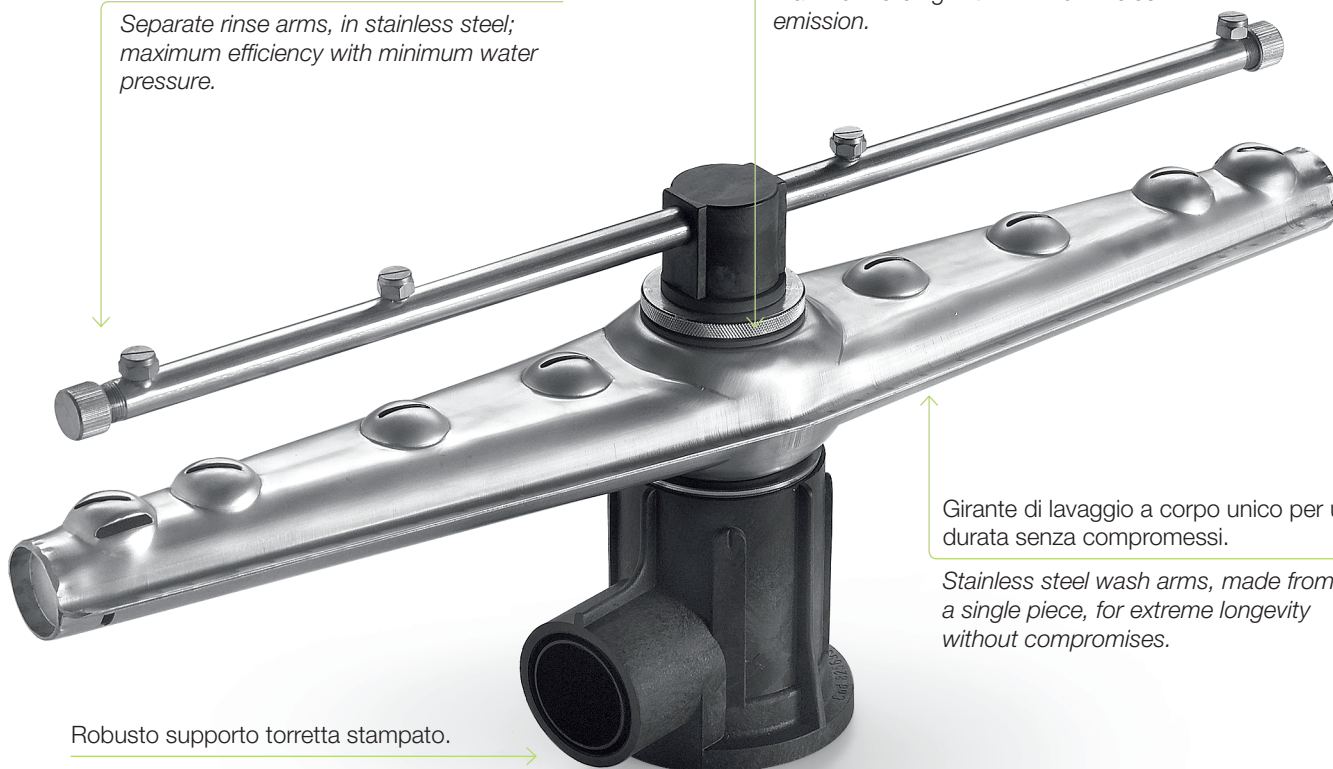

Girante di lavaggio a corpo unico per una durata senza compromessi.

Stainless steel wash arms, made from a single piece, for extreme longevity without compromises.

Robusto supporto torretta stampato.

Turret support moulded and robust

TS723

A DOPPIA PARETE INOX
DOUBLE SKINNED STAINLESS STEEL

LAVAPIATTI / LAVASTOVIGLIE

- > Comandi laterali
- > Stop ciclo su apertura porta
- > Dosatore del brillantante incorporato
- > Porta bilanciata con ammortizzatori a gas
- > Filtro inox aspirazione pompa
- > Alimentazione 380/415V 3F 50Hz
- > Potenza max. 5.3 Kw (picco)



DISHWASHER / WAREWASHER

- > Side controls
- > Safety cycle stop on door opening
- > Built-in rinse-aid dispenser
- > Balanced door with gas shock absorbers
- > Stainless steel filter on washing pump
- > Power supply 380/415V 3F 50Hz
- > Max power 5.3 Kw

In dotazione

- > 1 x cesto quadro piano
- > 1 x cesto quadro piatti
- > 1 x portaposate
- > 1 x tubo di carico
- > 1 x tubo di scarico (già installato)

Supplied with

- > 1 x flat square basket
- > 1 x square plate basket
- > 1 x cutlery basket
- > 1 x inlet hose
- > 1 x drain hose (already fitted)



trifase
3-phase

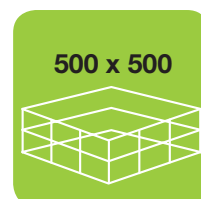
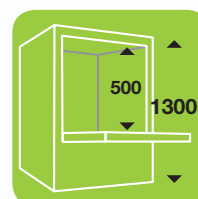

500 x 500

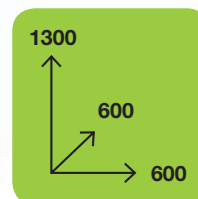

pizza

TS721 monofase

- > Alimentazione 220/240V 1F 50H
- > Potenza max. 3.3 Kw

- > Power supply 220/240V 1F 50H
- > Max power 3.3 Kw



monofase
single-phase
ciclo 300 sec.
300 sec. cycle



Cerniere forzate, senza bisogno di ingombranti tiranti esterni. Massima ergonomia e robustezza.

Ergonomic design with reinforced door hinges, for maximum strength and reliability, without external tie rods.

modelli models

TS723 (TS721)

TS723 (TS721) Ps

TS723 (TS721) Det

TS723 (TS721) Det Ps

caratteristiche features

modello standard
standard model

pompa di scarico automatica
automatic drain pump

dosatore del detergente liquido incorporato
built-in liquid detergent dispenser

dosatore del detergente liquido incorporato
pompa di scarico automatica
built-in liquid detergent dispenser
automatic drain pump

TS983

A DOPPIA PARETE INOX
DOUBLE SKINNED STAINLESS STEEL

DISHWASHER / WAREWASHER

- > Side controls
- > Safety cycle stop on door opening
- > Built-in rinse-aid dispenser
- > Balanced door with gas shock absorbers
- > Lock key for continuous washing (Std and Det models)
- > Stainless steel filter on washing pump
- > Power supply 380/415V 3F 50Hz
- > Max power 6.8 Kw

LAVAPIATTI / LAVASTOVIGLIE

- > Comandi laterali
- > Stop ciclo su apertura porta
- > Dosatore del brillantante incorporato
- > Porta bilanciata con ammortizzatori a gas
- > Tasto blocco lavaggio infinito (modelli standard e Det)
- > Filtro inox aspirazione pompa
- > Alimentazione 380/415V 3F 50Hz
- > Potenza max. 6.8 Kw (picco)

In dotazione

- > 1 x cesto quadro piatti
- > 1 x cesto rete larga inox
- > 1 x inserto inox trasversale per teglie
- > 2 x portaposate
- > 1 x tubo di carico
- > 1 x tubo di scarico (già installato)

Supplied with

- > 1 x square plate basket
- > 1 x stainless steel large grid rack
- > 1 x stainless steel insert for pots
- > 2 x cutlery basket
- > 1 x inlet hose
- > 1 x drain hose (already fitted)

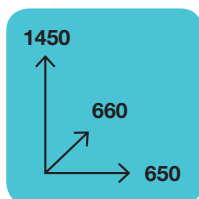
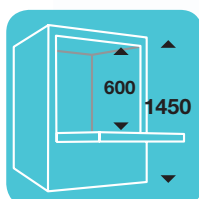
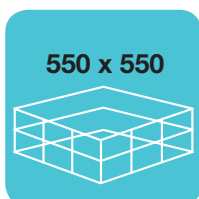

modelli models	caratteristiche features
TS983	modello standard standard model
TS983 Ps	pompa di scarico automatica automatic drain pump
TS983 Det	dosatore del detergente liquido incorporato built-in liquid detergent dispenser
TS983 Det Ps	dosatore del detergente liquido incorporato pompa di scarico automatica built-in liquid detergent dispenser automatic drain pump

CONSIGLIO / ADVICE



Per un buon lavaggio...

...Serve un buon risciacquo! Utilizzare un addolcitore per acque calcaree garantisce posate e bicchieri senza ombra di macchia.

For good and effective washing...

... You need efficient rinsing! Using a water softener for calcareous water will guarantee a perfect result on your dishes.

TS103

LAVAPIATTI A CAPOT
HOOD-TYPE DISHWASHER



Rotazione maniglia su cuscinetti a sfera inox.

Lifting handle design with stainless steel ball bearings.



Scorrimento capote su colonne inox da 3,5 centimetri di diametro.

Hood sliding on 3,5 cm diameter stainless steel columns.

LAVAPIATTI A CAPOT

- > Comandi laterali su entrambi i lati (per montaggio ad angolo)
- > Stop ciclo su apertura capote
- > Dosatore del brillantante incorporato
- > Scorrimento capote su colonne inox \varnothing 35 mm
- > Maniglia ovale ergonomica con rotazione su cuscinetti a sfera inox
- > Alimentazione 380/415V 3F 50Hz
- > Potenza max. 6.8 Kw (picco)

In dotazione

- > 2 x cesto quadro piatti
- > 1 x cesto quadro piano
- > 2 x portaposate
- > 1 x tubo di carico
- > 1 x tubo di scarico (già installato)



modelli models

caratteristiche features

TS103 modello standard
standard model

TS103 Ps pompa di scarico automatica
automatic drain pump

TS103 Det dosatore del detergente liquido incorporato
built-in liquid detergent dispenser

TS103 Det Ps dosatore del detergente liquido incorporato
pompa di scarico automatica
*built-in liquid detergent dispenser
automatic drain pump*

HOOD-TYPE DISHWASHER

- > Side controls on both sides (for corner mounting)
- > Safety cycle stop on hood opening
- > Built-in rinse-aid dispenser
- > Hood sliding on \varnothing 35 mm stainless steel columns
- > Ergonomic oval handle sliding on stainless steel ball bearings
- > Power supply 380/415V 3F 50Hz
- > Max power 6.8 Kw

Supplied with

- > 2 x square plate basket
- > 1 x flat square basket
- > 2 x cutlery basket
- > 1 x inlet hose
- > 1 x drain hose (already fitted)

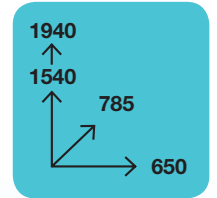
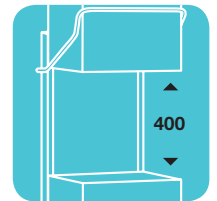
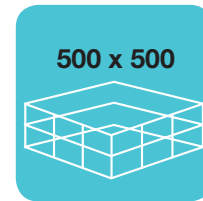

I vantaggi del lavoro in linea

Un impianto di lavaggio completo di tavoli preparazione e disimpegno garantisce una estrema performance produttiva.

Due operatori che cooperano a monte ed a valle dell'apparecchiatura possono raggiungere una produttività molto proficua che ripaga l'investimento sul sistema in modo molto veloce, soddisfacendo le esigenze della ristorazione in sala con un minor numero di stoviglie.

CONSIGLIO / ADVICE



Advantages of the washing line

A washing system which is complete with the service tables guarantees the maximum production performance. Two operators working together at the start and the end of the washing line can reach a very high level of productivity, assuring a very quick payback on Your investment.

ACCESSORI

ACCESSORIES

Tavoli di servizio

IN ACCIAIO INOX (disponibili in versione destra e sinistra)

L x P x H cm

80 x 70 x 85
100 x 70 x 85
120 x 70 x 85
140 x 70 x 85
160 x 70 x 85

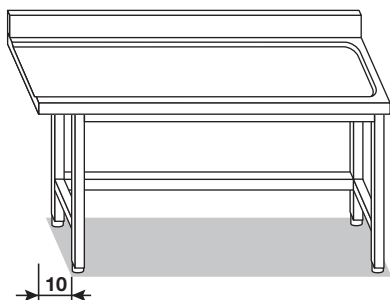

TAVOLO USCITA CON ALZATINA
OUT TABLE WITH BACKSPLASH

L x P x H cm

80 x 70 x 85
100 x 70 x 85
120 x 70 x 85
140 x 70 x 85
160 x 70 x 85

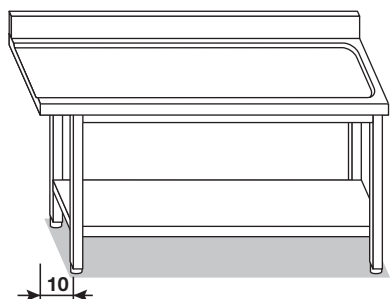

TAVOLO USCITA CON RIPIANO ED ALZATINA
OUT TABLE WITH SHELF AND BACKSPLASH

L x P x H cm

100 x 70 x 85
120 x 70 x 85
140 x 70 x 85
160 x 70 x 85
180 x 70 x 85
200 x 70 x 85

Vasca - Wash basin
50 x 40 x 25

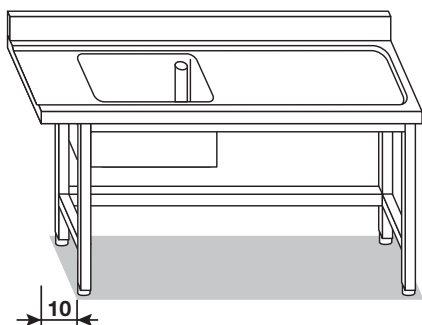

TAVOLO USCITA CON VASCA ED ALZATINA
OUT TABLE WITH WASH BASIN AND BACKSPLASH

Service tables

IN STAINLESS STEEL (available in left and right configuration)



L x P x H cm

100 x 70 x 85
120 x 70 x 85
140 x 70 x 85
160 x 70 x 85
180 x 70 x 85
200 x 70 x 85

Vasca - Wash basin
50 x 40 x 25

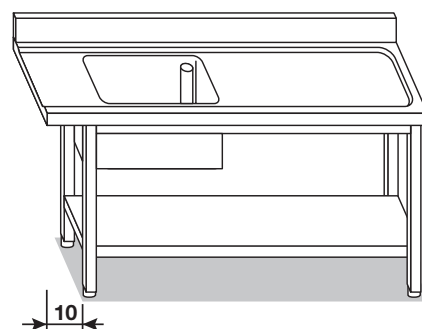

TAVOLO USCITA CON VASCA, RIPIANO ED ALZATINA
OUT TABLE WITH WASH BASIN, SHELF AND BACKSPLASH

L x P x H cm

140 x 70 x 85
160 x 70 x 85
180 x 70 x 85
200 x 70 x 85

Vasca - Wash basin
50 x 40 x 25

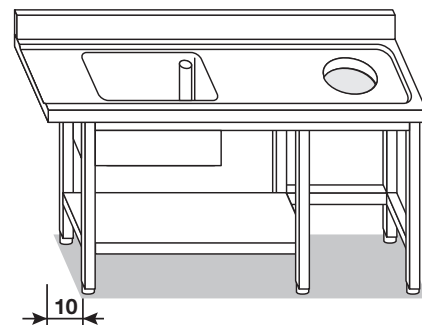

TAVOLO USCITA CON VASCA, FORO, RIPIANO ED ALZATINA
OUT TABLE WITH WASH BASIN, HOLE, SHELF AND BACKSPLASH

Cesti

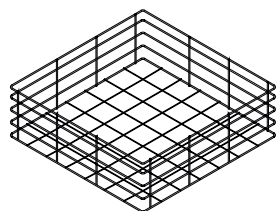

> cesto 37x37 quadro piano
> cesto 40x40 quadro piano
> cesto 50x50 quadro piano

> 37x37 flat square basket
> 40x40 flat square basket
> 50x50 flat square basket

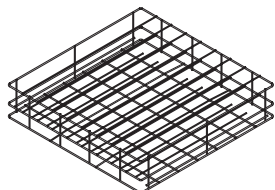

> cesto 50x50 quadro piatti
> cesto 55x55 quadro piatti

> 50x50 square plate basket
> 55x55 square plate basket

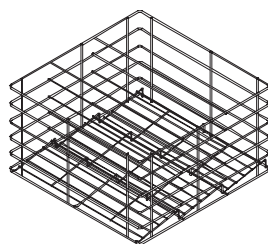

> cesto 37x37 quadro bicchieri
> cesto 40x40 quadro bicchieri

> 37x37 square glass basket
> 40x40 square glass basket

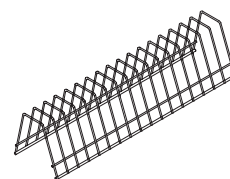

> inserto porta piattini

> plate rack insert

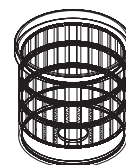

> inserto porta posate

> cutlery basket

Baskets

Pattumiere

A TENUTA STAGNA, IN ACCIAIO INOX

standard standard
50 lt - ø 40 x 62
75 lt - ø 48 x 60
100 lt - ø 48 x 72



con pedale with pedal
50 lt - ø 40 x 62
75 lt - ø 48 x 60
100 lt - ø 48 x 72



Wastebags

WATERTIGHT, IN STAINLESS STEEL

portasacco waste-bag holder
ø 48 x 85



portasacco con pedale waste-bag holder with pedal
ø 48 x 85



Carrelli

IN ACCIAIO INOX

L x P x H cm

83 x 53 x 98

93 x 53 x 98

103 x 53 x 98

93 x 63 x 98

103 x 63 x 98



a due ripiani con invaso
edged 2-tier

Trolleys

IN STAINLESS STEEL

L x P x H cm

83 x 53 x 98

93 x 53 x 98

103 x 53 x 98

93 x 63 x 98

103 x 63 x 98



a tre ripiani con invaso
edged 3-tier

Rubinetti di alta qualità

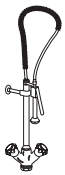

doccia monoforo
single-hole spray

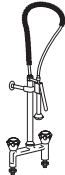

doccia biforo
two-hole spray



doccia monoforo
con rubinetto
single-hole spray
with tap

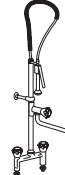

doccia biforo
con rubinetto
two-hole spray
with tap



doccia monoforo
a leva
single-hole spray
with lever tap

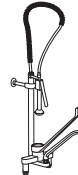

doccia biforo
a leva
two-hole spray
with lever tap

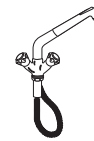

monoforo con
doccia estraibile
single-hole,
pull-out shower head



monoforo a leva con
doccia estraibile
single-hole lever,
pull-out shower head

Addolcitori

ADDOLCITORI INOX ESTERNI

- > Funzionamento a resine a scambio ionico
- > Singolo rubinetto per una eccellente praticità d'uso
- > Esclusiva funzione di rimescolo delle resine
- > Rigenerazione con sale comune
- > Portata 700 lt/min
- > Pressione min/max: 1/8 bar
- > Temperatura acqua di alimentazione min/max 4°C/15°C



Water softeners

STAINLESS STEEL EXTERNAL WATER SOFTENERS

- > Working with ionic resins
- > Single tap for an easy and simple use
- > Exclusive resins shake feature
- > Regeneration of resins with common salt
- > Capacity: 700 lt/min
- > Min/max pressure: 1/8 bar
- > Min/max inlet water temperature: 4°C/15°C

capacità lt capacity L	h. max mm max h. mm	capacità sale kg salt capacity kg	intervallo di rigenerazione in lt regeneration interval in litres
8	400	1	1.000
12	500	1,5	1.500
16	600	2	2.100
20	900	2,5	3.000

Dati di prestazione riferiti ad una durezza dell'acqua di 30° Francesi
Performance data refer to water hardness of 30 French degrees.



Teikos

catering equipment

Teikos s.r.l. - Via del Santo, 221 - 35010 Limena (PD) Italy
Tel. +39 049 767722 (767283) - Fax +39 049 769909 - www.teikos.net - teikos@teikos.net